

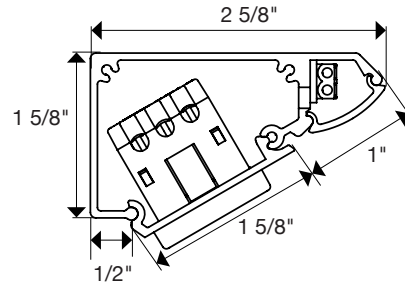

# Sempria® LED Lighted Power Strip

Tamper Resistant Angle Power Strip with  
Built-in Sempria LED Lighting



Section

Switches only available in Black and White

**1/2**  
watt

## SEMPRIA® LIGHTED POWER STRIP

PART NUMBER	LENGTH	DRIVER	TOTAL WATTS	#OF RECEPT.	RECEPT. COLOR	FINISH	LUMENS <small>Based on 3000K (approx. per fixture)*</small>	KELVIN TEMP
LPS10-H-Driver3-1Color-FinishTemp	10½"	Integral (DV), Remote (RM)	3W	1	B, G, W	BK, BZ, SN, WT	270	2700K, 3000K
LPS12-H-Driver6-2Color-FinishTemp	12½"	Integral (DV), Remote (RM)	6W	2	B, G, W	BK, BZ, SN, WT	540	2700K, 3000K
LPS18-H-Driver9-2Color-FinishTemp	18½"	Integral (DV), Remote (RM)	9W	2	B, G, W	BK, BZ, SN, WT	810	2700K, 3000K
LPS24-H-Driver12-4Color-FinishTemp	24½"	Integral (DV), Remote (RM)	12W	4	B, G, W	BK, BZ, SN, WT	1080	2700K, 3000K
LPS30-H-Driver15-4Color-FinishTemp	30½"	Remote Only (RM)	15W	4	B, G, W	BK, BZ, SN, WT	1350	2700K, 3000K
LPS36-H-Driver18-4Color-FinishTemp	36½"	Remote Only (RM)	18W	4	B, G, W	BK, BZ, SN, WT	1620	2700K, 3000K

**1/4**  
watt

## SEMPRIA® LIGHTED POWER STRIP

PART NUMBER	LENGTH	DRIVER	TOTAL WATTS	#OF RECEPT.	RECEPT. COLOR	FINISH	LUMENS <small>Based on 3000K (approx. per fixture)*</small>	KELVIN TEMP
LPS10-Q-Driver2-1Color-FinishTemp	10½"	Integral (DV), Remote (RM)	2W	1	B, G, W	BK, BZ, SN, WT	207	2700K, 3000K
LPS12-Q-Driver4-2Color-FinishTemp	12½"	Integral (DV), Remote (RM)	4W	2	B, G, W	BK, BZ, SN, WT	414	2700K, 3000K
LPS18-Q-Driver6-2Color-FinishTemp	18½"	Integral (DV), Remote (RM)	6W	2	B, G, W	BK, BZ, SN, WT	621	2700K, 3000K
LPS24-Q-Driver8-4Color-FinishTemp	24½"	Integral (DV), Remote (RM)	8W	4	B, G, W	BK, BZ, SN, WT	828	2700K, 3000K
LPS30-Q-Driver10-4Color-FinishTemp	30½"	Integral (DV), Remote (RM)	10W	4	B, G, W	BK, BZ, SN, WT	1035	2700K, 3000K
LPS36-Q-Driver12-4Color-FinishTemp	36½"	Integral (DV), Remote (RM)	12W	4	B, G, W	BK, BZ, SN, WT	1242	2700K, 3000K





# Sempria® LED Lighted Power Strip

Tamper Resistant Angle Power Strip with  
Built-in Sempria LED Lighting

## FEATURES

- Tamper Resistant APS with integrated LED Lighting
- Designer finishes to blend with any decor
- 3-Year Limited Warranty
- Integral or Remote Driver
- Dimmable (with compatible dimmer)
- No UV or IR

## APPLICATIONS

- Under Cabinets
- Under Fixed Shelving
- Office Cubicles
- Shops & Garages

## DIMMING OPTIONS

PART NUMBER	DESCRIPTION
DVELV-300P	300W Diva slide dimmer
DVELV-303P	300W Diva slide dimmer 3-way
MAELV-600-Color	Maestro electronic smart dimmer
MA-R-Color	Preset smart remote (for multiple switching)

## SPECIFICATIONS WITH DRIVER

Construction Materials:	Powder Coated Extruded Aluminum (heatsink), IR Acrylic (lens)
Wattage:	1/4 Watt, 1/2 Watt LEDs
Color Temp (Kelvin):	2700K (Warm White) or 3000K (Neutral White)
CRI:	90+
LED Beam Angle:	120°
Input Voltage:	120V
LED Spacing:	1 1/2"
Mounting:	Wood Screws & Wall Anchors
Wiring:	12 ga. Romex
Environment:	Dry Only

## RECEPTACLE COLORS

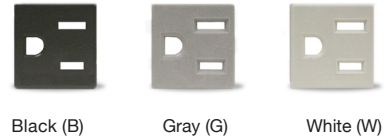

## FINISHES



## OPTIONAL INSTALLATION COMPONENTS

PART NUMBER	DESCRIPTION
APS-Switch	Rocker Switch (available in Black or White)

*Task Lighting retains the right to modify the design of our products without prior notice*

## SPECIFICATIONS WITHOUT DRIVER

Construction Materials:	Powder Coated Extruded Aluminum (heatsink), IR Acrylic (lens)
Wattage:	1/4 Watt, 1/2 Watt LEDs
Color Temp (Kelvin):	2700K (Warm White) or 3000K (Neutral White)
CRI:	90+
LED Beam Angle:	120°
Input Voltage:	120V (receptacles) & 15 Volt DC (lighting)
LED Spacing:	1 1/2"
Mounting:	Wood Screws & Wall Anchors
Wiring:	18/2 solid (recommended)- for Lighting 12 ga. Romex- for Receptacle
Environment:	Dry Only
Max Run:	Refer to Driver Specs

## REMOTE DRIVERS

PART NUMBER	DESCRIPTION
TLD-D30WSO	30W hardwire 15VDC
TLD-D45WSO	45W hardwire 15VDC
TLD-D60WSO	60W hardwire 15VDC
TLD-D75WSO	75W hardwire 15VDC



## Sempria® LED Lighted Power Strip

Tamper Resistant Angle Power Strip with  
Built-in Sempria LED Lighting

### WITH Driver and Switch

LPS36-Q-Driver18-4Color-FinishTemp

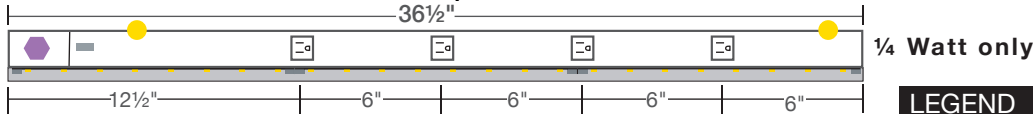

LPS30-Q-Driver15-4Color-FinishTemp

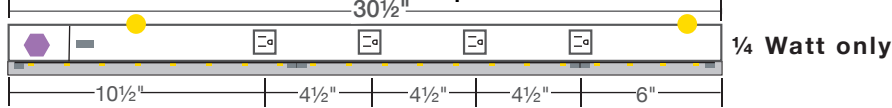

LPS24-Driver12-4Color-FinishTemp

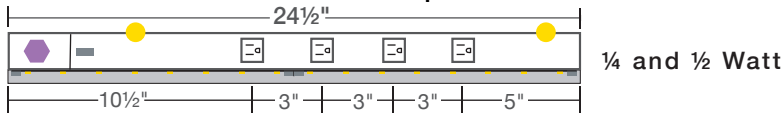

LPS18-Driver9-2Color-FinishTemp

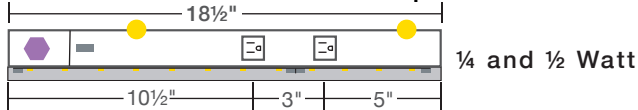



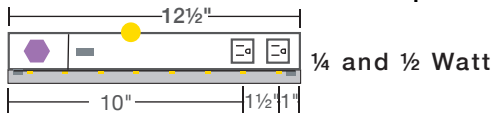

LPS12-Driver6-2Color-FinishTemp

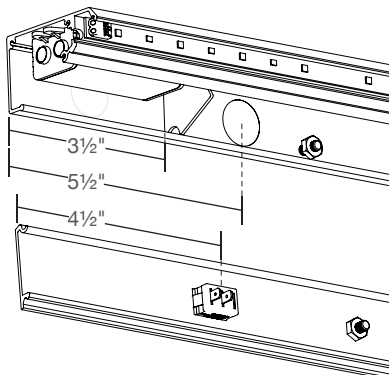

LPS10-Driver3-1Color-FinishTemp



#### LEGEND

-  = Receptacle (Available in White, Gray, or Black)
-  = Switch (Available in Black or White- 4 1/2" from left side)
-  = Divider Plate (Low Voltage)
-  = Driver
-  = Knock-out (1 1/2" from right side - 5 1/2" from left side)

#### CUSTOM OPTIONS

- Custom lengths from 10 1/2" - 92" (larger sizes will have a seam when assembled)
- 120 Volt integral switch (*available in black or white only*)
- Additional receptacles
- Custom receptacle/switch placement
- 1/2 Watt, Integral Driver = 24" or less
- 1/2 Watt, Remote Driver = up to 92"
- 1/4 Watt, Integral Driver = 36" or less
- 1/4 Watt, Remote Driver = up to 92"

#### CUSTOM OPTION DETAILS

- Receptacles must be a minimum of 2" apart (on center)
- Receptacles must be a minimum of 2" from end. (Requires wire entry at opposite end of fixture)
- Custom charges will apply - Call for a quote and assistance with your custom order
- Call for lead time
- Additional Options- Call Task Lighting